

**4" - 12" A-2362 RESILIENT WEDGE
GATE VALVES - SL. x FL.**

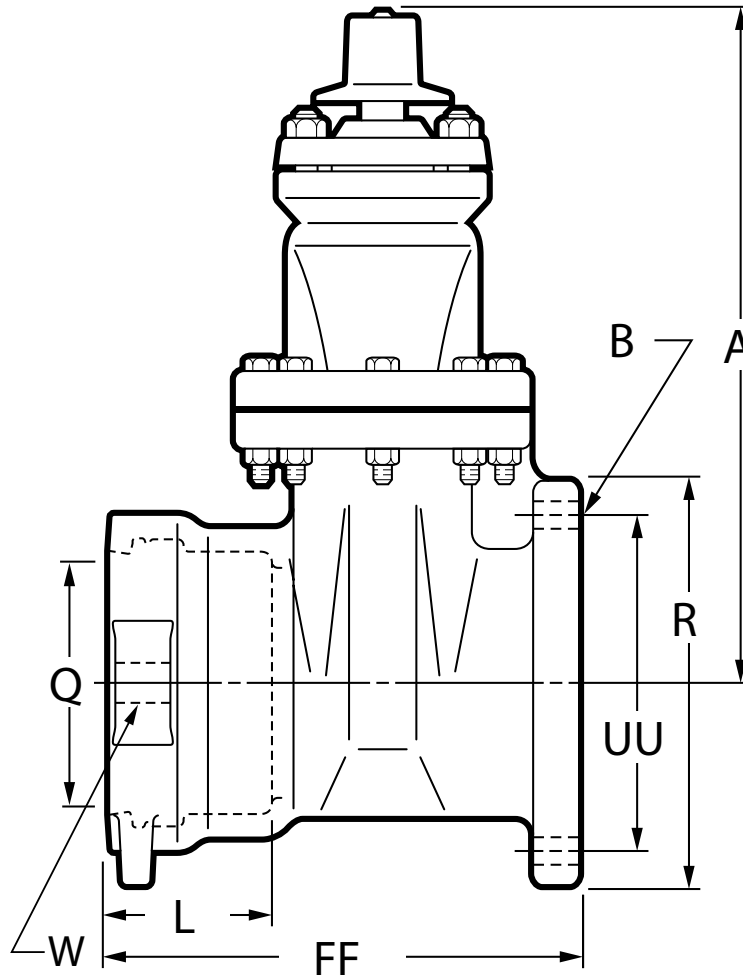

10.39

Shaded area indicates change Rev. 1-15



Dimensions

Dimension	Nominal Size				
	4"	6"	8"	10"	12"
A	14.19	18.00	21.50	25.50	28.62
Q (bore)	4.30	6.30	8.30	10.30	12.30
L	4.12	4.38	5.62	5.62	5.62
R	9.00	11.00	13.50	16.00	19.00
UU (bolt circle diameter for FL)	7.50	9.50	11.75	14.25	17.00
B (number and size of holes for FL)	8--.75	8--.88	8--.88	12--1.00	12--1.00
W (distance between strapping lug holes across face of valve ends)	8.62	10.62	13.12	16.38	18.12
FF	10.91	12.73	14.72	15.75	16.35
Turns to open	14	20.5	26.5	33	38.5
Weight*	98	152	260	400	565

*All dimensions are in inches. All weights are in pounds and are approximate.