

MUELLER

INSTA-TITE™ 2.0 CONNECTION

Fast, easy, and strong connections
for CTS, IPS, and IPS PE Pipe.



The Insta-Tite 2.0 connection simplifies making connections to PE tubing, Copper tubing, PEP pipe and PVC pipe without the need for wrenches. Stab-fittings allow the user to push the pipe into the end of the connection and have a secure installation. The new Insta-Tite 2.0 design does not require beveling PVC pipe.

Trusted stab-fitting for water distribution, now with copper capabilities, the Insta-Tite 2.0 connection helps to decrease installation time and provide a stronger connection.

EASE OF USE

- > Stab the pipe firmly into the connection.
- > No heating, flaring, threading, cementing, nut tightening, or liner required. Working pressure is equal to the fitting or pipe connected to the adapter.

RELIABILITY

- > "One-way" stainless steel grip ring lets pipe stab-in easily yet prevents pullout
- > Provides high resistance to external forces such as line movement, backfilling or accidental disturbances
- > Internal gasket provides positive leak-tight seal

PROVEN PERFORMANCE

- > Mueller has conducted extensive testing on the Insta-Tite 2.0 Connection Design:
- > Insta-Tite 2.0 Connections are designed for CTS O.D. tubing or IPS pipe.

- 1 Stainless Steel Grip Rings**
"One-way" stainless steel grip ring lets pipe stab-in easily yet prevents pullout
- 2 Easy Identification**
Color-coded guide rings identify CTS or IPS capability

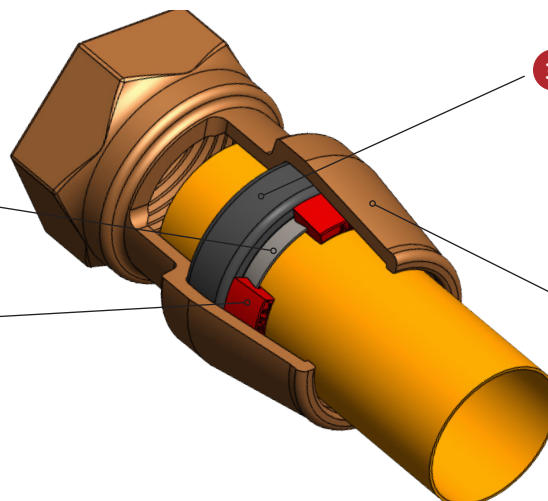

- 3 Leak-Tight Seal**
Resilient gasket provides positive leak-tight seal
- 4 Brass Body**
Strong brass body resists corrosion

INSTA-TITE™ 2.0 CONNECTION PRODUCT LINE

IPS

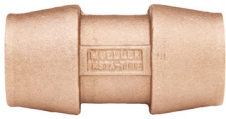

Insta-Tite X Insta-Tite

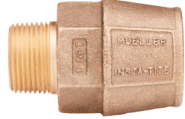

MIP X Insta-Tite

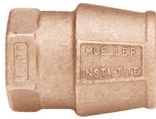

FIP X Insta-Tite

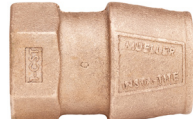

FCS X Insta-Tite

CTS

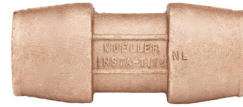

Insta-Tite X Insta-Tite

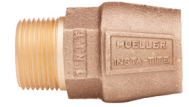

MIP X Insta-Tite

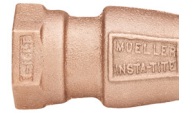

FIP X Insta-Tite



FCS X Insta-Tite

Item Number	Item Description	Size
015456 250N-2	IT x FIP	3/4"
015073 250N-2	IT x FCS	3/4"
014229 215N-2	IT x MP 5/8x3/4-3/4	3/4"
015408 330N-2	IT x IT coupling	1"
015426 330N-2	IT x MIP	1"
015426 254N-2	IT x MIP	1" x 3/4"
015456 330N-2	IT x FIP	1"
015456 254N-2	IT x FIP	1" x 3/4"
015073 330N-2	IT x FCS	1"
015073 254N-2	IT x FCS	1" x 3/4"
014229 330N-2	IT x MP 1	1"
014229 254N-2	IT x MP 3/4x1	1" x 3/4"

Item Number	Item Description	Size
015406 250N-2	IT CTS x IT CTS coupling	3/4"
015424 250N-2	IT x MIP	3/4"
015457 250N-2	IT x FIP	3/4"
015074 250N-2	IT x FCS	3/4"
014230 215N-2	IT x MP 5/8 x 3/4-3/4	3/4"
015406 330N-2	IT CTS x IT CTS coupling	1"
015424 330N-2	IT x MIP	1"
015457 330N-2	IT x FIP	1"
015074 330N-2	IT x FCS	1"
014230 330N-2	IT x MP 1"	1"
015408 250N-2	IT x IT coupling	3/4"
015426 250N-2	IT x MIP	3/4"

Ready to learn more?

Scan the QR code to get started.



For more information about Mueller or to view our full line of water products, please visit muellewp.com or call Mueller customer service at 1.800.423.1323.

Mueller refers to one or more of Mueller Water Products, Inc. (MWP), a Delaware corporation, and its subsidiaries. MWP and each of its subsidiaries are legally separate and independent entities when providing products and services. MWP does not provide products or services to third parties. MWP and each of its subsidiaries are liable only for their own acts and omissions and not those of each other. Mueller brands include Mueller®, Echologics®, Hydro Gate®, Hydro-Guard®, HYMAX®, i2O®, Jones®, Krausz®, Mi.Net®, Milliken®, Pratt®, Pratt Industrial®, Sentryx®, Singer®, and U.S. Pipe Valve & Hydrant. Please see muellewp.com/brandsto to learn more.

© 2023 Mueller. All Rights Reserved. The trademarks, logos and service marks displayed in this document are the property of Mueller, its affiliates or other third parties. Products above marked with a section symbol (§) are subject to patents or patent applications. For details, visit www.mwppat.com. These products are intended for use in potable water applications. Please contact your Mueller Sales or Customer Service Representative concerning any other application(s).

